

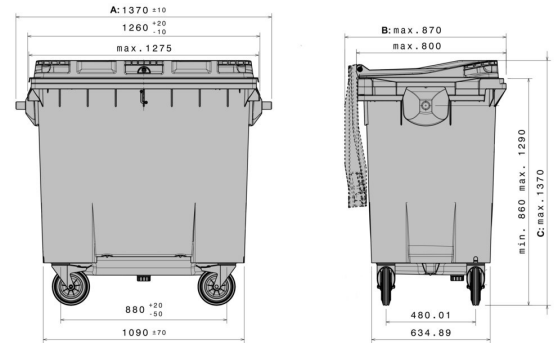



MGBneo⁴ 770 l

770 l



Technical Data*1

External Dimensions L x W x H (mm)	Length (mm): 1370 ±10	Width (mm): max. 870	Height (mm): max. 1370
Volume (l)	770 l		
Material Body / Material Lid	PE / PE		
Holding Capacity (kg)	 308kg		
Available colours	yellow, green, blue, red, anthracite		

Characteristics

Container corresponds to:	EN 840, RAL-GZ 951/1
Travelling gear:	4 x Ø-200 mm castor wheels, standard equipped with wheel stop
Receiver:	Comb lift
Prepared for transponder:	Yes

Extra equipment / Accessories*2

- Automatic lock
- Directional lock for castor wheel
- Triangular lock
- Noise insulation plugs
- Glas slot

Loading quantities (Pcs / Approximate amount)

On request

Labelling

On the lid, on the body



*1 All specifications quoted are subject to change. Craemer reserve the right to make changes to product design and specification. Dimensions are stated according to DIN EN 840. Variations within the tolerances given in the norm are possible.

*2 Extra equipment, accessories, as well as other colours are available at extra cost and on request.